

ORC-7T-E

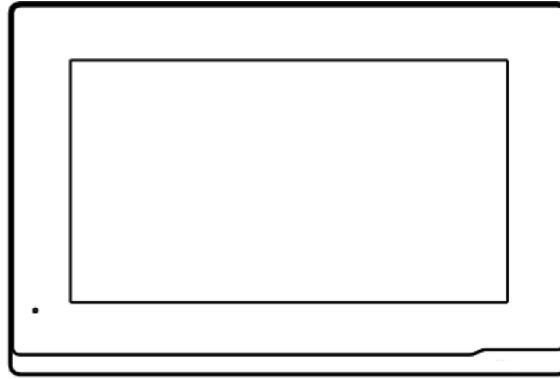

Manual and User Guide

7" Capacitive Touch Screen

Semi Surface installation

Android 10 System

Powered by PoE or optional power adapter (DC12V/2A)

Support SIP 2.0 protocol, easy integration with other SIP devices

Compatible with 3rd party application

Package contents



- (1x) Wall Bracket
- (2x) Fixing Screws
- (2x) Wiring looms
- (8x) 2.2K resistors

Overview

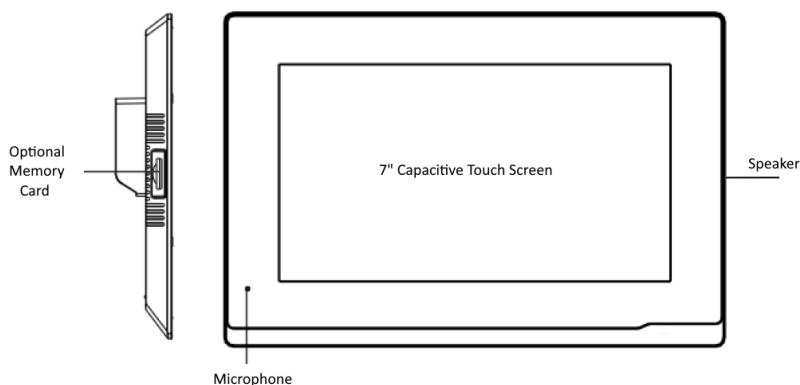

Remarks

Please follow the user manual for correct installation and testing. If there is any doubt please contact our tech-support team.

The illustration shown here is only for reference. If there is any difference, please take the actual product as the standard.

The product and batteries must be handled separately from household waste. When the product reaches the end of service life and needs to be discarded, please contact the local administrative department and put it in the designated collection points in order to avoid the damage to the environment and human health caused by any disposal. We encourage recycling and reusing the material resources.

Technical Information



System: Android 10
RAM: 1 GB
ROM: 8 GB
Power Supply: PoE (802.3af) or DC 12V/2A
Standby Power: 3 W
Rated Power: 10 W
Wi-Fi: IEEE802.11 b/g/n,@2.4GHz (Optional)
TF Card Slot: 1
Ethernet Port: 1 x RJ45, 10/100 Mbps adaptive
Resolution: 1024 x 600
Working Temperature: -10°C to +55°C
Storage Temperature: -40°C to +70°C
Working Humidity: 10% to 90% (non-condensing)

Quick User Guide Tips

Changing Home Page icons





To change the home page, hold down for several seconds until the  appears.

Select and Press  to remove and then select  to save, or  to cancel

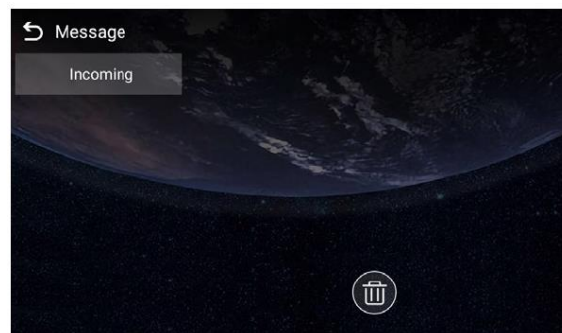

Messaging



Press the  icon to enter messages. Press  to return to Homepage

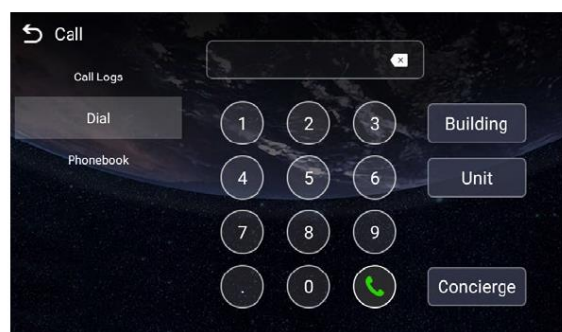

Calling other apartments



Press the  icon to enter calling page. Press  to return to Homepage

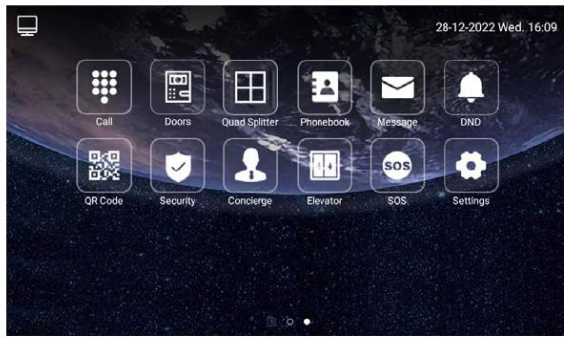

Activating DND (Do not disturb)

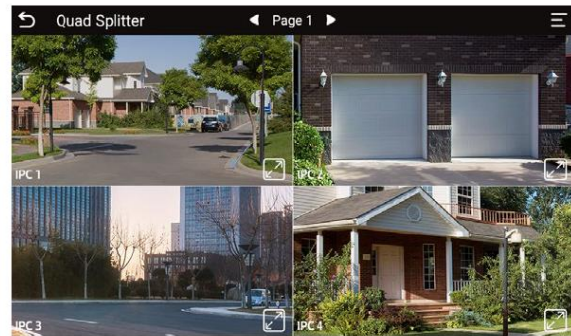

Press the  icon to activate and deactivate DND. Press  to return to Homepage

Quad Splitter CCTV option



Press the  icon to activate CCTV page. Press  to return to Homepage

QR code (if enabled)

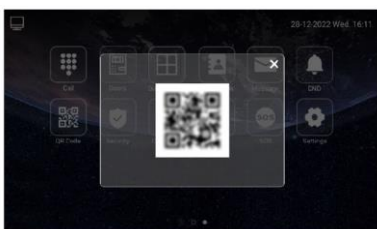

Allows 3rd party apps like smart home and calling App.

Elevator / Lift function (if enabled)

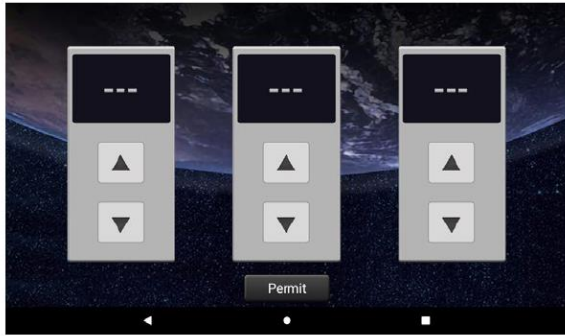

Allows calling of the Lift / Elevator with-in the building

SOS calling (if enabled)

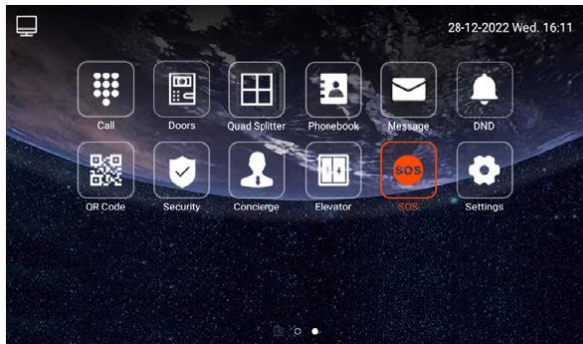

Press SOS button to enable a call to alarm centre.

Display Settings

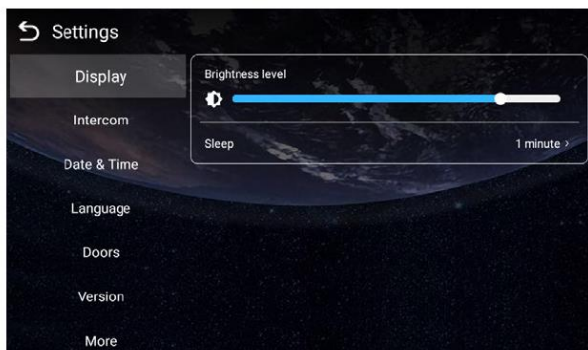

Installation Notes

Installing Screen to the wall

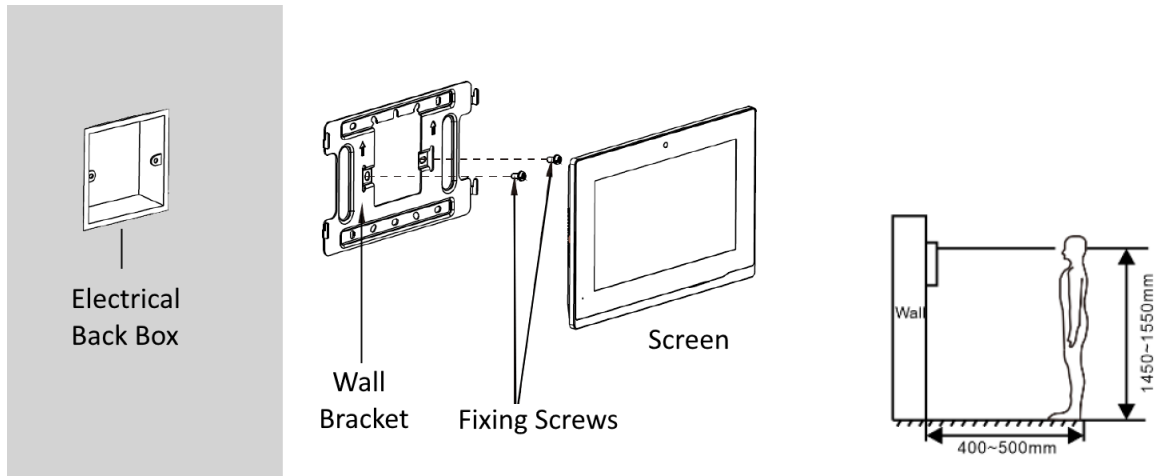

Best practice is to install the wall bracket onto an electrical Back Box.

Typical installation height for back box is 1450mm (if DDA is required then install at 1200mm)

Installing screen with desk bracket

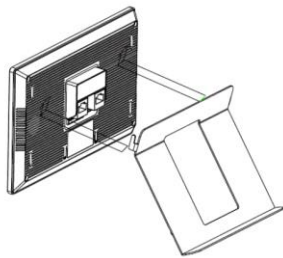

Insert the Metal base ORC-7T-E-DB into the top-hole inserts.

Wiring PoE

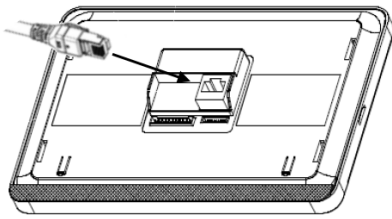

Insert the Poe Ethernet cable into the Touch Screen

Wiring Alarm inputs

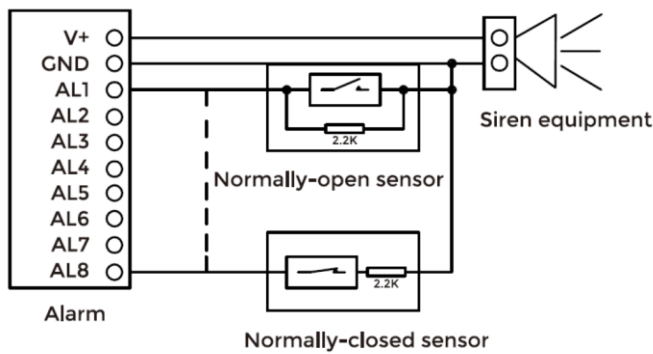

Using 2.2K resistors will instruct the Touch Screen Monitor to monitor the input connections.

The input will reduce from 3.3V to 1.6V DC

Wiring RS485 modules

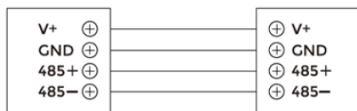

Connect A, B, GND to any RS485 Devices requiring communication to the Touch Screen.

12V DC (100mA) output

Wiring Relay

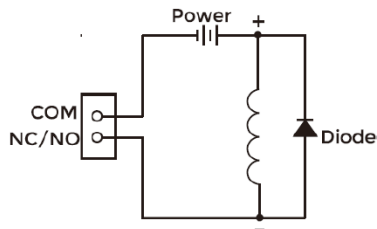

When connecting to an inductive load device such as a relay or electromagnetic lock, you are recommended to use a diode 1A/400V (included in the accessories) in anti-parallel with the load device to absorb inductive load voltage peaks. The intercom will be better protected in this way.
2. The load current of the relay cannot be greater than 2A. See attached picture for more details.

Safety Instructions

In order to protect you and others from harm or the device from damage, please read the following information before using the device.

Do not install the device in the following places:

- in a high-temperature and moist environment or the area close to magnetic field, such as the electric generator, transformer or magnet.
- near the heating products such as electric heater or the fluid container.
- in the sun or near the heat source, which might cause discoloration or deformation of the device.
- in an unstable position to avoid the property losses or personal injury caused by the falling of device.

Guard against electric shock, fire and explosion:

- Do not use damaged power cord, plug or loose outlet.
- Do not touch the power cord with wet hand or unplug the power cord by pulling.
- Do not bend or damage the power cord.
- Do not touch the device with wet hand.
- Do not make the power supply slip or cause the impact.
- Do not use the power supply without the manufacturer's approval.
- Do not have the liquids such as water go into the device.

Clean Device Surface

- Clean the device surfaces with soft cloth dipped in some water, and then rub the surface with dry cloth.

Other Tips

- In order to prevent damage to the paint layer or the case, please do not expose the device to chemical products, such as the diluent, gasoline, alcohol, insect-resist agents, opacifying agent and insecticide.
- Do not knock on the device with hard objects.
- Do not press the screen surface. Overexertion might cause floppover or damage to the device.
- Please be careful when standing up from the area under the device.
- Do not disassemble, repair, or modify the device at your own discretion.
- The arbitrary modification is not covered under warranty. When any repair required, please contact the customer service centre.
- If there is abnormal sound, smell or fume in the device, please unplug the power cord immediately and contact the customer service centre.
- When the device isn't used for a long time, the adaptor and memory card can be removed and placed in dry environment.
- When moving, please hand over the manual to new tenant for proper usage of the device.